



Operating instructions  
Commercial flatwork ironer  
PM 1210  
PM 1214  
PM 1217

---

To avoid the risk of accidents or damage to the machine, it is **essential** to read these instructions before it is installed and used for the first time.

en-GB

# Contents

---

<b>Warning and Safety instructions</b> .....	3
Correct application .....	3
Technical and electrical safety .....	3
Operation .....	4
Using accessories .....	4
Notes on the use of this ironer .....	4
<b>Caring for the environment</b> .....	6
Disposal of the packing material .....	6
Disposal of your old machine .....	6
<b>Guide to the machine</b> .....	7
Control buttons on the Touch display .....	8
Display symbols on the control panel .....	9
Finger guard .....	10
Swing out bar .....	10
Flexible laundry feed for throughfeed .....	10
<b>Laundry preparation</b> .....	11
Residual moisture of the laundry .....	11
Preparing the laundry .....	11
<b>Operation</b> .....	12
Preparing for use .....	12
Ironing .....	12
Select a temperature .....	12
Changing the pre-set temperature for a temperature selection button .....	12
Selecting the ironer speed .....	13
Setting the ironer speed .....	13
Changing the pre-set roller speed for a roller speed selection button .....	13
Laundry feed .....	13
Pauses in ironing .....	13
Standby mode .....	14
FlexControl footswitch .....	14
Pick-off bands .....	14
After ironing .....	14
Ironing with a coin-operated payment system .....	14
<b>Notes</b> .....	15
Changing the temperature unit .....	15
Favourites setting .....	15
Increasing the life of the roller cover .....	15
Power failure during ironing .....	15
Peak load (optional accessory) .....	15
Fault messages .....	16
<b>Cleaning and care</b> .....	17
Cleaning and waxing the heater plate .....	17
Waxing the heater plate .....	17
Roller padding .....	18
Removing the roller cover .....	18
Fitting the roller cover .....	18
Miele Service .....	19

## Warning and Safety instructions

This ironer complies with current safety requirements. Inappropriate use can, however, lead to personal injury and damage to property.

To avoid the risk of accidents and damage to the ironer, please read these instructions carefully before using it for the first time. They contain important information on its safety, use and maintenance.

If other persons are being shown how to operate the ironer, they must be given or made aware of these important safety instructions.

Keep these instructions in a safe place and ensure that new users are familiar with the content. Pass them on to any future owner.

### Correct application

This ironer must be used as described in these instructions and must be checked on a regular basis to make sure it is functioning correctly. Maintenance must be carried out when necessary.

- ▶ This ironer must only be used for ironing articles which were washed in water and which have a care label stating that the article is suitable for machine ironing.
- ▶ This ironer is intended for use in commercial settings. It is not intended for use in the domestic environment. If the ironer is operated in a publically accessible place, it is the supervisor's responsibility to ensure suitable measures are in place to protect users from any source of risk or danger.
- ▶ This ironer is not intended for outdoor use.

### Technical and electrical safety

- ▶ This ironer should not be operated in the same room as dry-cleaning equipment using perchloroethylene or solvents containing CFCs.
- ▶ This ironer should only be operated in a suitable dry room.
- ▶ Only operate this ironer when all removable outer panels are in place so that it is impossible to touch an electrical component or moving part.
- ▶ Do not damage, remove or bypass the safety components or control elements of this ironer.
- ▶ Do not make any alterations to the ironer unless authorised to do so by Miele.
- ▶ If the controls or the electrical cabling insulation has been damaged, this ironer must not be used until it has been repaired.
- ▶ Repairs and other work by unqualified persons could be dangerous. The manufacturer cannot be held liable for unauthorised work. Repairs may only be carried out by a Miele authorised service technician.
- ▶ Faulty components must only be replaced by genuine Miele Original spare parts. The manufacturer can only guarantee that the machine fully complies with safety requirements when Miele replacement parts are used.

## Warning and Safety instructions

---

- ▶ The electrical safety of this ironer can only be guaranteed if connected to a correctly installed earthing system on site. It is most important that this standard safety requirement is present and tested regularly, and where there is any doubt the on-site electrical system should be tested by a qualified electrician. Miele cannot be held liable for damage or injury caused by the lack of or inadequacy of an effective earthing system.
- ▶ This ironer is only completely isolated from the electricity supply when switched off at the mains isolator, or the mains fuse is disconnected.

### Operation

- ▶ This ironer must not be operated unsupervised.
- ▶ This ironer can only be used by people with reduced physical, sensory, or mental capabilities or lack of experience or knowledge if they are supervised whilst using it or have been shown how to use it in a safe way and understand and recognise the consequences of incorrect operation.
- ▶ Please supervise children in the vicinity of the ironer and do not let them play with it.
- ▶ In the heated state and with the heater plate contacting the roller, there is a serious risk of burning if the edge of the heater plate on the laundry output side is touched.
- ▶ Do not set the ironing temperature higher than the temperature given on the care label of the item you intend to iron. The laundry could ignite if the ironing temperature is set too high.
- ▶ When ironing double layered items, do not reach in between the layers to straighten out the fabric. This is extremely dangerous as you may not be able to extract your hands in time. The same applies when ironing garments with pockets.
- ▶ The flexible laundry feed mechanism (depending on model) must only be operated from the front.
- ▶ Ensure the room in which the ironer is being used is sufficiently lit.
- ▶ Keep the working area around the ironer free from clutter.
- ▶ Always keep a fire extinguisher accessible in the rare event of textiles igniting. Items which are unsuitable for ironing or which have not been washed in water can catch fire.
- ▶ This ironer may only be used in mobile installations such as ships if a risk assessment of the installation has been carried out by a suitably qualified person. It is also imperative that all local and national safety regulations concerning the use of this ironer are observed.

### Using accessories

- ▶ Accessory parts may only be fitted when expressly approved by Miele. If other parts are used, guarantee, performance and product liability claims will be invalidated.

### Notes on the use of this ironer

- ▶ Only responsible people over the age of 16 years who have been fully trained in the use of the ironer should use the infeed table.
- ▶ When working with the ironer, always wear close fitting clothes and keep long hair tied back. Wide sleeves, apron straps, scarves and ties etc. could be taken in by the roller.

## Warning and Safety instructions

---

- ▶ Remove rings and bracelets before ironing.
- ▶ Smooth out folds as far away from the infeed on the infeed table as possible. Feed pillow cases and duvet covers into the ironer with the open end first. Do not take hold of the corners from the inside. Do not take hold of straps or ties etc. from the inside of garments
- ▶ Check daily that safety devices are correctly set. This ironer must only be used if all safety features are functioning correctly. This way you will avoid the danger of burns, squashed fingers and even loss of hands.
- ▶ Before switching to reverse make sure that nobody is endangered.

If other persons are being shown how to operate the ironer, they must be given or made aware of these important safety instructions.

Pass these instructions on to any future users/owners of the ironer.

## Caring for the environment

---

### Disposal of the packing material

The packaging is designed to protect the machine from damage during transportation. The packaging materials used are selected from materials which are environmentally friendly for disposal and should be recycled. Recycling the packaging reduces the use of raw materials in the manufacturing process and also reduces the amount of waste in landfill sites.

### Disposal of your old machine

Electrical and electronic machines often contain valuable materials. They also contain materials which, if handled or disposed of incorrectly, could be potentially hazardous to human health and to the environment. They are, however, essential for the correct functioning of your machine. Please do not therefore dispose of it with your household waste.

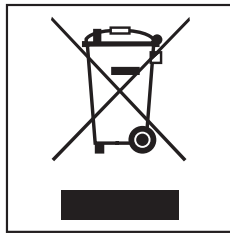

Please dispose of it at your local community waste collection / recycling centre or contact your Dealer for advice. Ensure that it presents no danger to children while being stored for disposal.

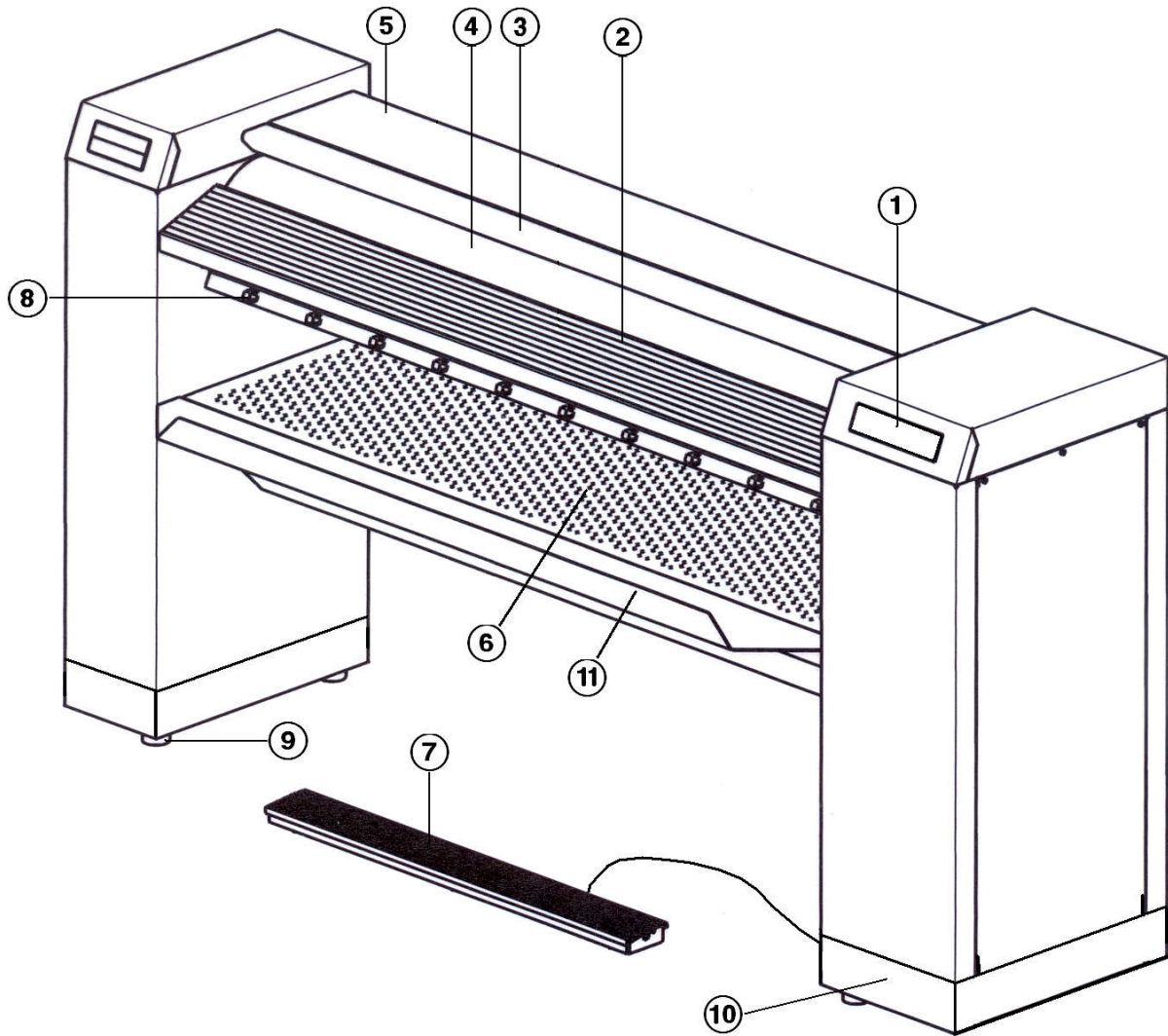

- ① Control panel (Touch display)
- ② Laundry infeed table
- ③ Finger guard
- ④ Roller
- ⑤ Heater plate with cover
- ⑥ Laundry outfeed table
- ⑦ FlexControl footswitch
- ⑧ Pick-off bands
- ⑨ Height adjustable screw feet
- ⑩ Plinth (optional)
- ⑪ Laundry box

Option	PM 1210	PM 1214	PM 1217
Swing out bar		X	
Flexible laundry feed			X
Spring padding			X
Plinth	X	X	X

# Guide to the machine

## Control buttons on the Touch display

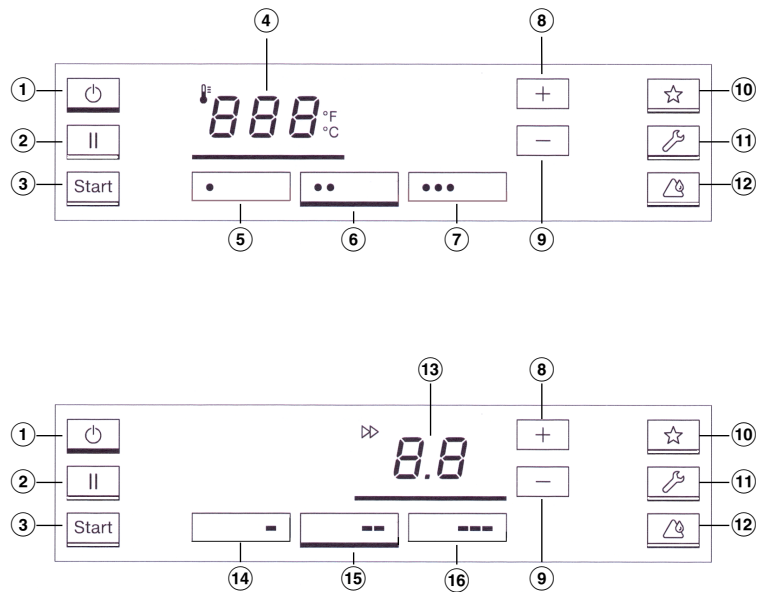

Top: temperature range, bottom: ironer speed range

- |                                       |                                       |
|---------------------------------------|---------------------------------------|
| ① On/Off, Standby                     | ⑨ Decrease temperature / roller speed |
| ② Pause                               | ⑩ Favourites programme                |
| ③ Start                               | ⑪ Maintenance position*               |
| ④ Temperature selection mode          | ⑫ Clean / Wax                         |
| ⑤ Temperature selection button 1      | ⑬ Roller speed selection mode         |
| ⑥ Temperature selection button 2      | ⑭ Roller speed selection button 1     |
| ⑦ Temperature selection button 3      | ⑮ Roller speed selection button 2     |
| ⑧ Increase temperature / roller speed | ⑯ Roller speed selection button 3     |

\* This button can be activated by Miele Service during commissioning.

When a button is pressed, it is highlighted with a bar underneath. When the Start button flashes, the ironer can be started.



## Display symbols on the control panel

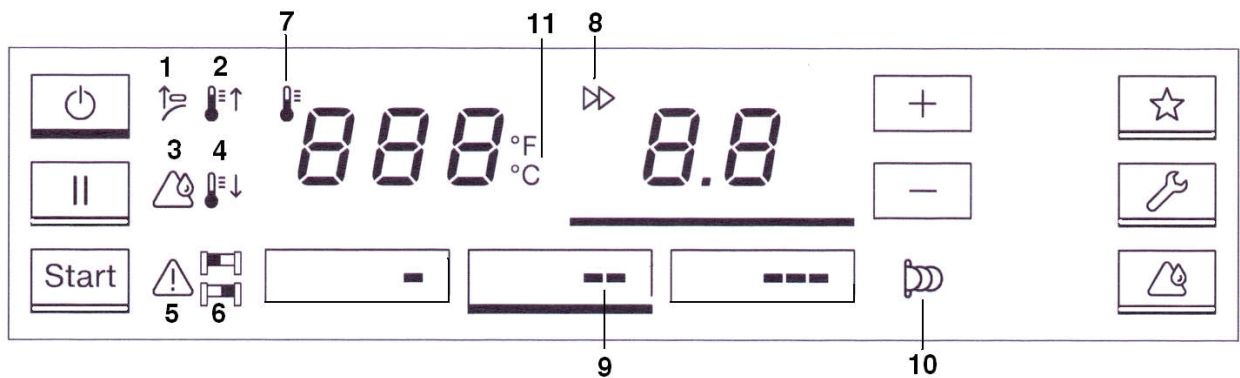

- ① Activate the finger guard
- ② Heating on / temperature increasing
- ③ Cleaning and waxing (PM 1217 only)
- ④ Heating off / temperature too high
- ⑤ General fault
- ⑥ Constant incorrect laundry feed, left / right
- ⑦ Pre-selection and temperature display in °C / °F
- ⑧ Pre-selection and roller speed display
- ⑨ Roller speed range
- ⑩ Coin operation mode
- ⑪ Switch temperature units

## Guide to the machine

### Finger guard

The finger guard is a safety feature which must be checked daily for proper functioning before the machine is used.

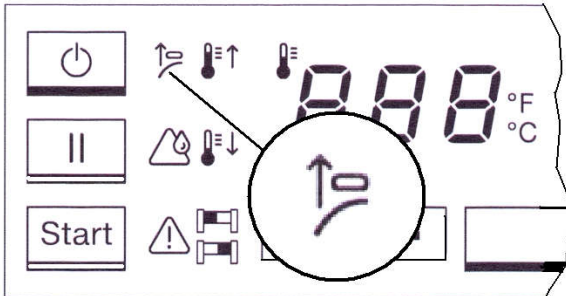

Activate the finger guard once when the "Finger guard" symbol starts to flash in the display.

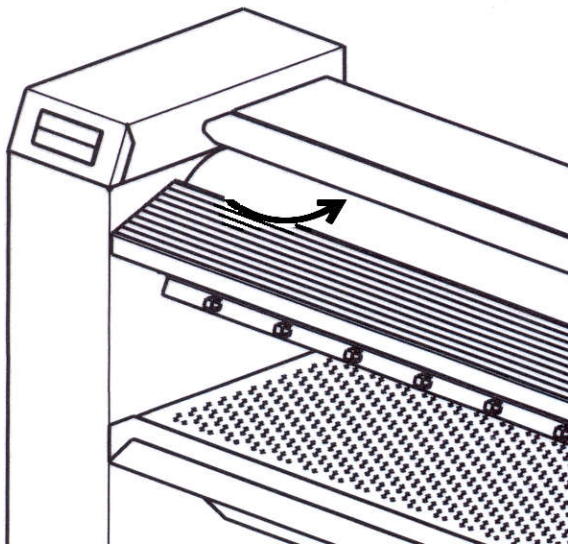

If finger tips get between the roller and the finger guard, the roller is stopped immediately and the heater plate is withdrawn. When this happens, the "Finger guard" display symbol will light up constantly. During reverse mode of the roller, the finger guard has no function. The ironer can be turned on again by pressing the start button.

Do not use the finger guard intentionally to switch off the machine.

### Swing out bar

(Optional accessory for PM 1214)

Ironed laundry can be placed over the swing out bar to prevent creasing.

### Flexible laundry feed for through-feed

(Optional accessory for PM 1217)

The flexible laundry feed mechanism enables laundry to be fed through to the back of the ironer for removal. It is particularly suitable for larger items of laundry such as sheets / duvet covers or table cloths.

The flexible laundry feed mechanism must only be operated from the front of the ironer.

There is a danger of burning if you touch the edge of the heater plate.



## Residual moisture of the laundry

For a good result and optimum ironing performance the ideal residual moisture level for the PM 1214 and PM 1217 lies between 15% and 25%, for the PM 1210 at 15%. The ideal residual moisture level depends on the composition of the fabric.

## Preparing the laundry

Before starting, sort the laundry according to type and fabric, taking note of advice on the care labels. We recommend sorting the laundry as follows:

Material	Symbol	Temperature
Nylon, other synthetics	●	100 - 110 °C
<i>then</i>		
Woollens, Silks	●●	111- 150 °C
<i>followed by</i>		
Cottons, linens	●●●	151 - 180 °C

To switch back to ironing at a lower temperature reduce the temperature to the required setting. The "Temperature" indicator light  will come on to let you know that the ironer is too hot to use. The heating elements will also switch off. The "Temperature" indicator light  will go out when the set temperature has been reached. Starched laundry should be ironed last to prevent any starch residues on the heater plate from affecting other items of laundry. Items with buttons should be passed through the ironer with the buttons facing into the roller padding. If they face upwards there is a danger of them being damaged or torn off when the item is passed through the ironer. A cloth should be placed over zips, metal buttons and hooks to protect the heater plate during ironing. Metal and plastic buckles and very bulky buttons should not be passed through the ironer.

Before using for the first time clean the heater plate by passing through a Miele cleaning cloth along the entire length of the roller. Then wax the heater plate, using the wax sparingly.

# Operation

## Preparing for use

- Switch on the on-site mains switch.
- Switch the ironer on by pressing the On / Off  button.

The "Finger guard" symbol will flash in the display.

- Now activate the finger guard by lifting it.

The finger guard is a safety feature which must be checked for proper functioning every time the ironer is switched on.

## Ironing

- After switching the ironer on, wait until it has reached the minimum ironing temperature.

The  symbol will appear in the display and the ironer will heat up.

The **Start** button begins to flash as soon as the ironer has reached the minimum temperature.

The ironer is ready for operation when the set temperature is reached and the  symbol no longer appears in the display.

- Now press the flashing **Start** button to start up the ironer.

The ironing process will begin.

**Tip:** Allow the roller to rotate for about 5 minutes to enable the heat to equalise between the heater plate and the roller.

 **Danger of burning on the edge of the heater plate.**

There is danger of burning if the edge of the heater plate is touched on the laundry outfeed side when the ironer is heated up and the heater plate is engaged. There is a warning sticker on the top and at the back on the housing.

## Select a temperature

- Select the temperature according to the type of fabric.

Material	Symbol	Temperature	Pre-set value
Nylon / Artificial silk	●	100 - 110 °C	110 °C
Silks / Wool-lens	● ●	111 - 150 °C	125 °C
Cottons / Linens	● ● ●	151 - 185 °C	180 °C

The temperature can be selected either using the preset temperature or by using the "Increase temperature" + or "Decrease temperature" – buttons.

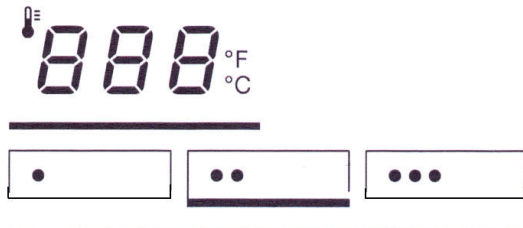

- Press the "Temperature selection mode" button  **888** on the control panel. The temperature field will then be highlighted with a bar underneath.
- To set a temperature range, press the relevant temperature selection button e.g. ● ● (pre-set as factory default to 125 °C). The button will be highlighted with a bar underneath.

## Changing the pre-set temperature for a temperature selection button

- Press the temperature selection button you want to change the value for.  
Keep it pressed in. The bar will light up underneath it and the current temperature value will appear in the display.
- Press the "Increase temperature" + or "Decrease temperature" – button to set the temperature you want to save for that button.
- Then press and hold the selected temperature selection button (which is highlighted with a bar underneath) until it flashes once.

The temperature value is now saved for that temperature selection button.

**Tip:** Allow the roller to rotate for about five minutes to enable the heat to equalise between the heater plate and the roller.

## Selecting the ironer speed

PM 1210 / PM 1214:

Symbol	Speed range	m/min
-	Low speed range	1.5 - 2.2
- -	Medium speed range	2.3 - 3.2
- - -	High speed range	3.3 - 4

PM 1217:

Symbol	Speed range	m/min
-	Low speed range	1.5 - 2.4
- -	Medium speed range	2.5 - 3.4
- - -	High speed range	3.5 - 4.5

Roller speed can be selected either using the preset speed range or changed using the "Increase roller speed" + or "Decrease roller speed" - button.

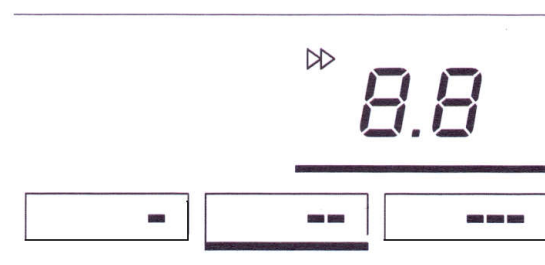

## Setting the ironer speed

- Press the "Roller speed selection mode" 8.8 button.

The roller speed display will then be highlighted with a bar underneath.

- Then press one of the three roller speed buttons, e.g. the "Roller speed 2" - - button.

The button will then be highlighted with a bar underneath and the ironer will operate at the pre-set roller speed for this button.

## Changing the pre-set roller speed for a roller speed selection button

- Press the roller speed button you want to change the speed for.

Keep it pressed in. The bar will light up underneath it and the current roller speed will appear in the display.

- Press the "Increase roller speed" + or "Decrease roller speed" - button to set the roller speed you want to save for that button.

- Then press and hold the selected roller speed button (which is highlighted with a bar underneath) until it flashes once.

The roller speed is now saved for that roller speed button.

- Then press the Start button.

## Laundry feed

- Lay the item parallel to the roller at the start of the laundry infeed table.

- Smooth the item.
- Feed the item into the machine.

**Tip:** Do not restrict ironing of smaller articles to any one part of the roller. Make use of the whole roller width. If laundry is continuously fed in on one side of the roller an infeed fault symbol will appear in the display (see display symbol ⑥ on the control panel).

## Pauses in ironing

- Press the "Pause" || button to go into Pause mode.

The heater plate is disengaged and the roller comes to a standstill. The heating will remain switched on.

- Press the Start button to start ironing again.

The ironer remains on ready to operate in Pause mode. If it is not used for a period of 10 minutes the temperature is reduced to 60 °C.

# Operation

## Standby mode

Standby mode is switched off at the factory. It can be reactivated by Miele Service. The time interval after which the ironer switches into Standby mode can be set between 1 minute and 30 minutes of inactivity. The ironer can be switched on again by pressing the "On / Off"  button

In Standby mode the heater plate is disengaged and the roller comes to a standstill. The heating is switched off.

## FlexControl footswitch

Steam ironing

- The "FlexControl" foot switch is used for operating the ironer in Steam mode to press laundry.

The roller stops when the ironer switches into Steam mode. The heater plate remains in contact.

To continue ironing

- Remove your foot from the foot switch to continue ironing.

When the foot switch is released, the roller starts to turn again automatically and the ironing process can continue.

The foot switch can also be configured by Miele Service so that when the foot switch is operated, the heater plate disengages and the roller stops.

## Pick-off bands

The pick-off bands are used for picking laundry off the roller.

The ironed laundry can be very hot when it comes out of the heater plate.  
Danger of burning.  
Wear gloves to protect your hands if necessary.

## After ironing

- After ironing let the roller run for approx. 5 minutes on minimum heating to let the roller covering dry out.
- Switch the ironer off by pressing the On / Off  button.

The heater plate will disengage and the fan will run for 10 minutes to cool down. The On / Off  button will flash during this time.

- Switch off the on-site main switch.

 Allow the ironed laundry to cool down before packing or stacking it. Hot laundry could self-ignite and cause a fire.

## Ironing with a coin-operated payment system

- Switch the ironer on by pressing the "On / Off"  button.

The  symbol will flash in the display.

- Insert the coin or token.

The  symbol will go out in the display.

- Select the temperature range according to the type of laundry.
- Select the roller speed you want.

When the  symbol goes out in the display, the ironer is ready to operate and the ironing time purchased will begin to count down.

- Press the start button to start the ironer.
- At the end of the ironing time, the heater plate disengages and the roller comes to a standstill. The  symbol flashes in the display. More ironing time can be purchased at any time.



## Changing the temperature unit

The temperature unit display can be changed from °C to °F by Miele Service.

## Favourites setting

Using the "Favourites" ☆ button, the most used combination of temperature and roller speed can be saved so that they can be accessed quickly and easily.

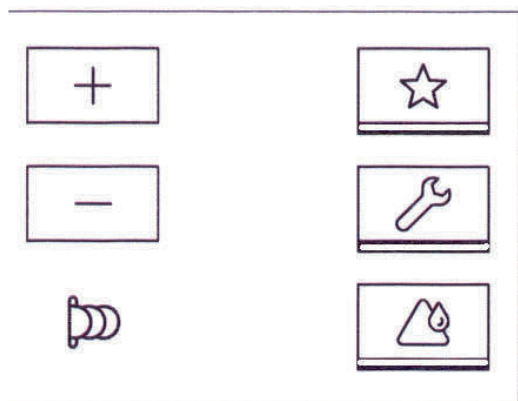

To save the desired parameters, press the "Favourites" ☆ button until it flashes once. The saved values are then accessed by pressing the "Favourites" ☆ button briefly. When you leave the "Favourites" function, the previously saved values are restored again.

## Increasing the life of the roller cover

During longer pauses in ironing, switch off the ironer or press the "On / Off" ⏻ button to enter Standby mode. This will considerably relieve the burden on the roller cover.

Avoid running the ironer without laundry. Do not restrict ironing of smaller articles to any one part of the roller. Make use of the whole roller width.

If it is frequently used on only one side, the heat is only absorbed on one side and the roller cover will wear unevenly. If laundry is continuously fed in on one side of the roller an infeed fault symbol will appear in the display and an audible tone will sound.

## Power failure during ironing

In the event of a power failure, the heater plate withdraws automatically. When power is restored you need to restart the ironer by pressing the Start button.

In the event of a longer power failure, the ironer must be switched on again by pressing the "On/Off" ⏻ button, operating the finger guard and pressing the Start button.

## Peak load (optional accessory)

If peak load is active, the heater plate switches off and "Temperature" and "Roller speed" flash in the display. Ironing can be continued using the residual heat in the heater plate until the ironer goes into "Pause" || mode.

## Notes

### Fault messages

When a fault occurs ironing is interrupted, the "Pause" **||** button flashes and a four-digit code appears in the display. Pressing the flashing "Pause" **||** button cancels the fault (the fault is stored in the fault memory). The "On/Off" **⏻** button flashes and ironing can be restarted.

If the fault message appears again, repeat the procedure or switch the ironer off and start again.

In the event of a malfunction call Miele Service.

F0	
F1	
F2	
F8	Heating fault
F20	
F24	
F25	
F39	
F40	
F41	
F42	Electronic module fault
F43	
F45	
F47	
F49	
F50	Drive fault
F53	
F57	Fan fault
F61	12 V (24V) voltage missing
F99	Machine locked
F104	Drive voltage too low
F108	General compressor fault
F120	Low voltage
F 4500 to F 4512	Control system fault



## Cleaning and waxing the heater plate

Regular cleaning and maintenance of the heater plate is essential for the protection of the motor and the roller cover. Please follow the notes in the Miele Ironing Handbook on ironing and cleaning and care. The heater plate must be waxed every time it is cleaned. Failure to do so can result in a considerable reduction in the life of the ironer.



The heater plate is made of aluminium. For this reason, do not use coarse scouring agents or abrasive cleaning cloths. For cleaning, only use the Miele cleaning set. It includes a cleaning cloth, waxing cloth, and ironer wax. This set can be ordered from Miele as an accessory.

Only use the cleaning cloth approved by Miele to clean the aluminium heater plate.

Because detergent and starch deposits can stick to the heater plate, it should to be cleaned before starting work, depending on the degree of soiling.

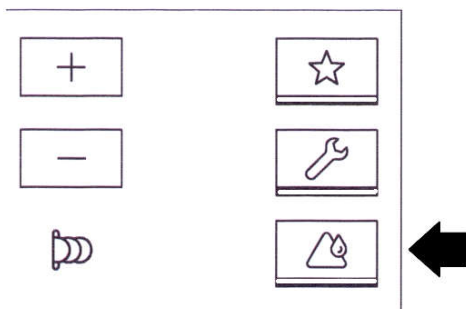
The ironer has a cleaning programme. The PM 1217 also has an indicator  which will light up in the display after 40 operating hours (factory default setting) to prompt you to clean and wax the heater plate. The interval at which the prompt appears is set by Miele Service.





To start cleaning mode, press the "Clean / Wax"  button and then press the temperature selection button . In this case, the temperature is lowered to 80 °C and the fan is switched off.

With heavier deposits, use the Miele cleaning cloth. While doing so, use the **lowest temperature setting** and the **lowest roller speed**. After cleaning, wax the heater plate as described in the following section. When waxing has been successfully carried out in waxing mode, the interval for the cleaning prompt indicator to appear (the PM 1217 has a factory default setting of 40 operating hours) is reset.

## Waxing the heater plate

To maintain the smooth surface of the heater plate, we recommend that it should be waxed sparingly with an ironer waxing cloth each working day.

To start waxing mode, first press the "Clean/Wax"  button and then "Temperature selection button 3" .

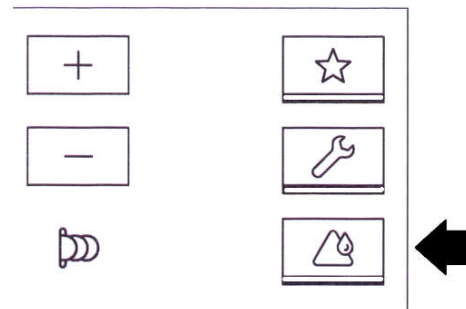

"Clean/Wax" button 

Wax the heater plate at maximum temperature, lowest speed and with the fan switched off. This setting is saved on the "Clean / wax"  button.

To activate the waxing function, press the "Clean / Wax"  button and hold it for longer than 3 seconds. To deactivate the function, press and hold the button again for longer than 3 seconds.

- To wax the heater plate with the waxing cloth, sprinkle the wax into the pocket of the waxing cloth and close the pocket.

Use the wax sparingly to prevent the roller cover becoming too smooth.

## Cleaning and care

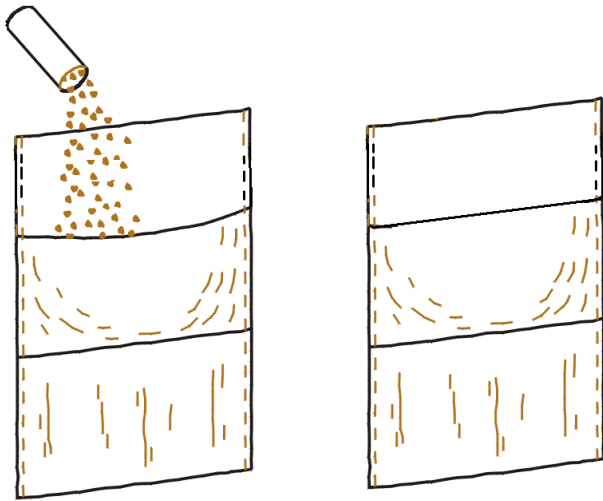

- As soon as the right temperature has been reached, the "Start" button starts to flash. Press this button to start the waxing process.
- Lay the pocket with the rubberised side facing **downwards** (i.e., towards the roller) and feed it into the ironer when hot (heater plate temperature: approx. 180 °C).

Do not feed the waxing cloth with the rubberised side facing upwards (i.e., towards the heater plate).

- Feed the ironing cloth into the ironer from the left or right at the necessary intervals across the entire working width of the roller.
- To deactivate the function, press and hold the "Clean / Wax"  button for longer than 3 seconds.



### Roller padding

Switch off the ironer and let the heater plate cool down before removing the roller cover for cleaning or replacement.



 The roller cover on the **PM 1217 with leaf-type roller padding** must only be removed or replaced by Miele Service. Otherwise there is the risk of damage to the leaf-type roller padding.

### Removing the roller cover

Please note that the laundry pick-off bands on the roller need to be fully retracted one after the other.

- Switch off the ironer using the "On /Off"  button.
- Press and hold the "Maintenance position"  button for more than three seconds.

The heater plate is withdrawn and is locked into this position.

- By repeatedly pressing the "Reduce temperature / Roller speed"  button, incrementally reverse the roller (jog mode).
- Take hold of the edge of the roller cover and lay it on the laundry infeed table.
- With the roller in reverse, now remove the roller cover.
- Press and hold the "Maintenance position"  button for more than three seconds to deactivate the maintenance position.

Wire wool residues may fall onto the laundry table whilst the roller cover is being taken off. These must be removed.

### Fitting the roller cover

- Switch on the ironer at the lowest temperature and lowest speed by pressing the start button.
- During a normal ironing process, place the roller cover on the ironer parallel to the roller and feed the roller cover over the roller.

The roller cover needs to be changed if there is a visible gap on the lower edge of the heater plate and roller (laundry out-feed) due to prolonged use.

Recovering the roller with wire wool must only be carried out by Miele Service.

The **diameter** of a new or re-upholstered roller must not be less than the following dimensions (including the roller cover).

PM 1210, PM 1214	PM 1217
min. 210 - max. 215 mm	min. 250 - max. 255 mm

Within this range the roller should be wound cylindrically over its entire length.

During the replacement of the roller padding, Miele Service should check whether the carbon brushes in the drive motor need to be replaced as well.

### Miele Service

In the event of a fault, contact Miele Service. Miele Service will require the model (M-Nr) and serial number (SN).

This information is given on the data plate.

**Use only genuine Miele original spare parts.** The Service department will also require model, serial number(SN) and material number (M-Nr) when ordering.

<b>Model</b>			
<b>SN:</b>	/ o o o o o o o o		
<b>Art.-Nr.</b>		<b>Mat.-Nr.</b>	
<b>IBN</b>			

## United Kingdom

Miele Co. Ltd.  
Fairacres, Marcham Road  
Abingdon, Oxon, OX14 1TW  
Professional Sales, Tel: 0845 365 6608  
E-mail: professional@miele.co.uk  
Internet: www.miele-professional.co.uk

## Australia

Miele Australia Pty. Ltd.  
ACN 005 635 398  
ABN 96 005 635 398  
1 Gilbert Park Drive, Knoxfield, VIC 3180  
Tel: 1300 731 411  
Internet: www.miele-professional.com.au

## China

Miele (Shanghai) Trading Ltd.  
1-3 Floor, No. 82 Shi Men Yi Road  
Jing' an District  
200040 Shanghai, PRC  
Tel: +86 21 6157 3500, Fax: +86 21 6157 3511  
E-mail: info@miele.cn, Internet: www.miele.cn

## Miele (Hong Kong) Limited

41/F - 4101, Manhattan Place  
23 Wang Tai Road  
Kowloon Bay, Hong Kong  
Tel: (852) 2610 1331, Fax: (852) 2610 1013  
Email: mielehk@miele.com.hk

## India

Miele India Pvt. Ltd.  
Ground Floor, Copia Corporate Suites  
Plot No. 9, Jasola  
New Delhi - 110025  
Tel: 011-46 900 000, Fax: 011-46 900 001  
E-mail: customercare@miele.in, Internet: www.miele.in

## Ireland

Miele Ireland Ltd.  
2024 Bianconi Avenue  
Citywest Business Campus, Dublin 24  
Tel: (01) 461 07 10, Fax: (01) 461 07 97  
E-Mail: info@miele.ie, Internet: www.miele.ie

**Manufacturer:** Miele & Cie. KG  
Carl-Miele-Straße 29, 33332 Gütersloh, Germany

# Miele

## PROFESSIONAL

## Malaysia

Miele Sdn Bhd  
Suite 12-2, Level 12  
Menara Sapura Kencana Petroleum  
Solaris Dutamas No. 1, Jalan Dutamas 1  
50480 Kuala Lumpur, Malaysia  
Phone: +603-6209-0288  
Fax: +603-6205-3768

## New Zealand

Miele New Zealand Limited  
IRD 98 463 631  
Level 2, 10 College Hill  
Freemans Bay, Auckland 1011, NZ  
Tel: 0800 464 353  
Internet: www.miele-professional.com.au

## Singapore

Miele Pte. Ltd.  
163 Penang Road  
# 04 - 03 Winsland House II  
Singapore 238463  
Tel: +65 6735 1191, Fax: +65 6735 1161  
E-Mail: info@miele.com.sg  
Internet: www.miele.sg

## South Africa

Miele (Pty) Ltd  
63 Peter Place, Bryanston 2194  
P.O. Box 69434, Bryanston 2021  
Tel: (011) 875 9000, Fax: (011) 875 9035  
E-mail: info@miele.co.za  
Internet: www.miele.co.za

## United Arab Emirates

Miele Appliances Ltd.  
P.O. Box 11 47 82  
Gold & Diamond Park, Sheikh Zayed Road  
Building 6 / Offices Nos. 6-214 to 6-220  
Dubai  
Tel: +971-4-341 84 44  
Fax: +971-4-341 88 52  
E-Mail: info@miele.ae  
Internet: www.miele.ae